

Today's Bride[®]

WEDDING SHOW



EXHIBITOR MANUAL

March 8th
2026

JOHN S. KNIGHT CENTER

77 E. MILL ST. AKRON, OH | HOURS: 11AM - 4PM

EXHIBITOR RESOURCES

TodaysBride.com/Pros/March

Today's Bride®

WEDDING SHOW

March 8, 2026
John S. Knight Center
11 AM - 4 PM

Show Day Exhibitor Help **Hotline**

440-482-1055

Need electricity? Trash overflowing?
Music too loud? Call or text to report
an issue without leaving your booth!

We are pleased to present the Exhibitor Manual for the John S. Knight Center Show on March 8, 2026.

Inside this manual, you'll have a record of important deadline dates, general guidelines, exhibitor rules, important exhibitor documents, and added-value promotional opportunities.

This entire manual, online forms, and additional helpful resources to prepare you for the show are available online at:

[NEW WEBSITE: TodaysBride.com/Pros/March](https://www.todaysbride.com/pros/march)

Please take the time to review the manual and website in their entirety, and share the information with your staff who will be setting up and/or working the show.

Thank you for being a part of the March Show! We are here to assist in any way we can before, during, and after the show. Don't hesitate to ask for our input on booth design ideas, marketing techniques, and more.

OFFICE: 330-670-9545

Jennifer Judy x14
jennifer@todaysbride.com

Jim Frericks x16
jim@todaysbride.com

Abby Frericks Crowder x12
abby@todaysbride.com

Kay Grey x22
kay@todaysbride.com

Julie Rauzan x24
julie@todaysbride.com

Laura Stratton x25
laura@todaysbride.com

Alyssa Myers x23
alyssa@todaysbride.com

DEADLINES

GUIDED TOUR OF JSK CENTER

WEDNESDAY, FEBRUARY 4, 2026 | 1:00-2:00PM

RSVP if attending to jennifer@todaysbride.com

FRIDAY, FEBRUARY 13, 2026

Pink Stuff-It Bag Program Materials Due

Deliver or ship 500 flat pieces to the Today's Bride Office
3550 Ridgewood Rd., Fairlawn, OH 44333

Learn More: [TodaysBride.com/pros/march-add](https://www.todaysbride.com/pros/march-add)

SUNDAY, FEBRUARY 15, 2026

Final Show Balance Due

FRIDAY, FEBRUARY 27, 2026

Return Credentials Form

Learn More: [TodaysBride.com/pros/march-cred](https://www.todaysbride.com/pros/march-cred)

FRIDAY, FEBRUARY 27, 2026

Order Additional Booth Rental Items

Call Angel at Miller's Party Rental at 330-753-9104 or email amk@millersparty.com to reserve. Rental fees apply.

Learn More: [TodaysBride.com/pros/march-add](https://www.todaysbride.com/pros/march-add)

FRIDAY, FEBRUARY 27, 2026

Reserve Space and Rentals for the Inspiration

Galleries (Tables, Gowns, Cakes, Photos)

To reserve gallery space: Contact Abby at 330-670-9545 x12 or email abby@todaysbride.com

To reserve complimentary rentals: Contact Angel at Miller's Party Rental at 330-753-9104 or amk@millersparty.com

SATURDAY, MARCH 7, 2026

Vendor Move-In Begins

Time: 12:45PM - 4:00PM

MOVE-IN **Saturday, March 7, 2026** **12:45 PM – 4 PM**

Sunday, March 8, 2026 **8:00 AM – 10:30 AM**

ALL EXHIBITORS must unload at the upper **South Broadway Street** lot off the loading dock area and enter through Dock Door 2 (**PINK ARROW**)

A Today's Bride employee will greet you to give you unloading instructions and your booth number.

SHOW HOURS **Sunday, March 8, 2026** **11 AM – 4 PM** Silent Opening: 10:45 AM, be ready!

Fashion Shows **12:30 PM & 2:30 PM**

MOVE-OUT **Sunday, March 8, 2026** **4 PM**

Exhibitors may begin to dismantle their booth displays (No earlier than 4PM)

The takedown, removal, or repackaging of booth materials and/or displays during posted show hours is strictly prohibited. Not only is this disrespectful to attendees and neighboring booths, but it poses a hazard while transporting materials through the event facility. Early tear down will result in forfeiture of the lead list and a \$100 fine.

- ➔ **IMPORTANT! UNLOADING IS PROHIBITED** through the main front door on East Mill Street.
- ➔ We suggest you bring your own dolly to wheel your materials in and out quickly.
- ➔ Should move-in or move-out require additional help, a few complimentary porters will be on hand to assist. Refer to the JOHN S. KNIGHT CENTER EXHIBITOR INFORMATION SUMMARY for specific rules and regulations that relate to the facility (page 15).

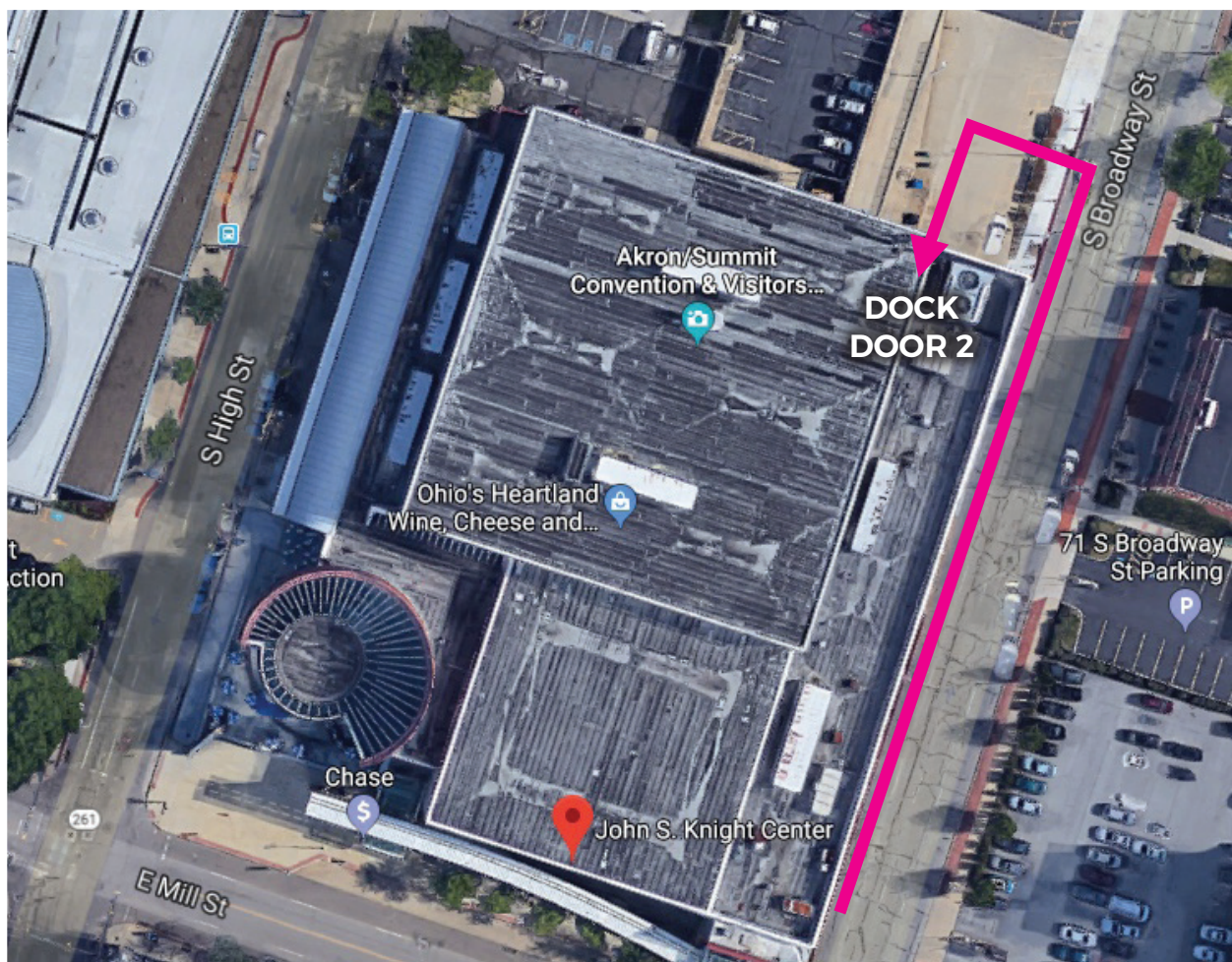

Today's Bride®

WEDDING SHOW

March 8, 2026
John S. Knight Center
11 AM - 4 PM

Show Day Exhibitor Help **Hotline**

440-482-1055

Need electricity? Trash overflowing?
Music too loud? Call or text to report
an issue without leaving your booth!

PARKING

The CITY lots are free of charge starting at 6:00pm on Friday continuing through Sunday. There are other PRIVATE lots available for a fee. See posted rates for the fees.

FOOD SAMPLE GUIDELINES

Selling food products is prohibited. All sampling requests are to be submitted in writing to Today's Bride before the show. Sampling is limited to a 2-oz. portion for food and a 3-oz. portion for a beverage. The items being sampled must be part of your business services. Alcoholic samples are prohibited.

DELIVERIES

The John S. Knight Center cannot be held responsible for any shipment of goods accepted at the facility. As a building rule, JSK will accept shipments up to three (3) business days (Monday - Friday, 9am to 4pm) before the event.

IDENTIFYING BRIDES

Instant identification. Engaged attendees will be wearing a "I Said Yes!" Today's Bride sticker. If the sticker is **PINK**, that means they already have a venue. If the sticker is **GREEN**, that means they do not have a venue.



LUNCH OPTIONS

Outside food and drink is not permitted to be brought into the John S. Knight Center. Concession areas will be available throughout the show with ample seating.

FREE PUBLIC WIFI

Use the "John S. Knight Center Guest" network. Open your internet browser and click on "Agree and Continue."

OHIO TRANSIENT TAX LICENSE

Exhibitors are responsible for complying with all vendor-licensing requirements. To obtain additional information and/or apply for an Ohio Transient Vendor's License, call 888-405-4089.

ELECTRIC

To order electric that is not included in your contracted booth space, please order from John S. Knight Center directly using the URL provided below.
(URL: www.visitakron-summit.org/knight-center/exhibitors/service-orders)

LIABILITY & INSURANCE

The Exhibitor is responsible for insuring its exhibit, personnel, display, automobiles, trailers, and materials against any damage or loss resulting from theft, fire, accidents, or any other cause. The Exhibitor acknowledges and assumes all risks associated with the use of the exhibit space and its surroundings. The Exhibitor agrees not to make any claims, demands, or legal actions against Today's Bride/Jadlyn, Inc, the Show sponsors, or the facility hosting the Show for any loss, damage, or injury incurred by the Exhibitor, its officers, directors, agents, representatives, employees, or their respective property.

Neither Today's Bride/Jadlyn, Inc. nor the facility will be liable for the loss or damage of equipment, products, goods, exhibits, or other materials owned, rented, or leased by the Exhibitor, regardless of the cause.

**REFER TO PAGE 15 TO FAMILIARIZE YOURSELF WITH
JOHN S. KNIGHT CENTER'S BUILDING RULES & REGULATIONS.**

BOOTH REGULATIONS

INCLUDED WITH SINGLE FURNISHED BOOTHS & LARGER:

- 8' high BLACK back pipe & drape
- 3' high side rails to separate your booth from neighbors
- 6' rectangle table covered in standard BLACK linen
- 2 chairs, if needed
- Company Name Placement Sign
- Nametags for Staff

*Tabletop booths include a covered 4' table with black linen and 1 chair.

*Naked unfurnished booths do not include a covered table or chairs.

Below are the booth design regulation guidelines. For a SINGLE BOOTH, plan within a 9' x 9' area due to vertical poles & bases taking up an extra foot.

1. Displays taller than 8' must get approval from Today's Bride 30 days prior to the show. The backdrop must be tastefully finished on the back side.
2. Pipes or trusses placed at the front of the booth space are acceptable provided the sides of the space do not obstruct the neighboring booth and there is a clear line of sight from both sides.
 - Don't position retractable banners at the front of your booth space. Move halfway back or towards the back.
 - The front 5' of your exhibit may not exceed 4' in height, unless it's a see-through structure.
 - Property or displays taller than 4' must be placed into the rear half of the exhibit space.
3. Stay within the space confines of your booth. Exhibitors are prohibited from standing in the aisles or having their booth displays extend into the aisles.
4. If you plan to uplight your booth backdrop, you must bring or rent your own pipe & drape backdrop to place in front of the drape that is shared with the exhibitor behind you. The light will show through the thin drape.

If you are concerned your exhibit is not within the above guidelines, contact the Today's Bride team at: 330-670-9545 or email shows@todaysbride.com. If your exhibit isn't within the guidelines, you may be asked to make changes during move-in.

Exterior of any part of display facing a booth must be finished or suitably decorated.

Signage may not read into neighboring booths.

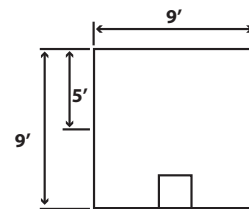
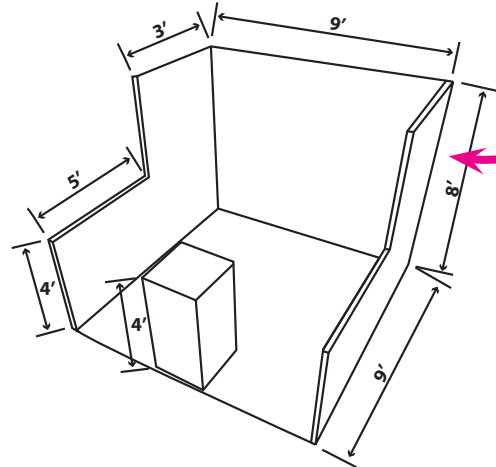

Overhead

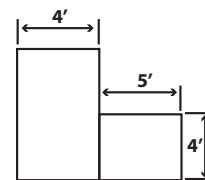

Left Side

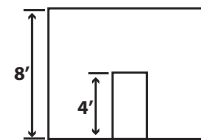

Front



PRE-SHOW PREP

12 weeks before the show:

- Download the Exhibitor Manual to prepare and track deadlines
Today'sBride.com/Pros/March
- Set Goals for the Show
 - Number of appointments
 - Testing a new product
 - Taking deposits
 - Signing contracts
- Plan your booth design
 - Layout • Decor • Flooring
 - Banners • Signage • Electric Access
- Order marketing materials: flyers, promo items, samples, show special to offer, literature for brides Pink "Stuff-It" Bags (if contracted)

6-4 weeks before the show:

- Stuff-it Bag Materials delivered to Today's Bride by **February 13, 2026**
Our address is **3550 Ridgewood Road, Fairlawn, OH 44333.**
- Order any extra rentals from a decorator, rental company, or venue
- Prepare a way to collect hot leads at the show (guest book, paper, or electronic forms)
- Pre-promote your presence at the show: share on social media, website, emails, voicemail & more
- Post online banner images promoting your booth and/or show special. Banners are located on the Exhibitor Manual website: **Today'sBride.com/Pros/March**

3 weeks before the show:

- Proof your online listing on Today'sBride.com
- Audit your design & branding on your website and social media

2 weeks before the show:

- Submit your Sign & Nametag Credentials Form by **February 27, 2026**
- Submit your Show Special to post on Today'sBride.com
- Create a packing list of what to bring to the show (see right)
- Schedule & train your staff on booth etiquette, rules, the sales process, and show specials
- Plan parking and lunch options for your staff
- Prepare lead collection forms and the follow-up process (timing of phone calls, emails, direct mail, show special deadlines)
- Review the Exhibitor List online to strategize your networking

POST-SHOW PREP

After the show:

- Follow up on your hot leads from the show immediately
- Download the registered attendee list once alerted that it's available
- Continue working the leads throughout the attendees' engagement
- Renew the next show date to keep your online listing active

PACKING LIST

- ♥ Electrical Cords & Surge Protector
- ♥ Mobile Device Chargers
- ♥ Sales Literature
- ♥ Business Cards
- ♥ Appointment Book
- ♥ Clipboards
- ♥ Booth Design Layout
- ♥ Dolly or Transporting Devices (Suitcase or Wagon)
- ♥ Masking Tape, Scotch Tape, Shipping Tape
- ♥ Scissors, Stapler, Safety Pins, Straight Pins
- ♥ Portable Vacuum/Steamer
- ♥ Pens, Sharpie Marker
- ♥ Trash Bags
- ♥ Aspirin, Band-Aids, Second Pair of Shoes
- ♥ Hand Sanitizer
- ♥ Lead Collection Forms (or laptop/tablet)
- ♥ Breath Mints
- ♥ Good Selling Plan & Attitude

THE RULES & REGULATIONS

NOTE: It is your responsibility to understand and abide by these rules.

Our insurance carrier and facilities instructed us to strictly enforce the show rules and regulations as indicated on your show contract. This will ensure a safe and enjoyable trade show experience not only for participating businesses but, more importantly, our valued attendees. Please read and adjust your presentation and set-up display if necessary.

Review and share these guidelines with your staff scheduled to work your booth prior to the event.

1) Booth staff and all display materials must stay within their contracted booth space and not infringe upon the aisle walkways or other booth spaces. All aisles must remain clear of obstruction. Maximum backdrop height is 8' tall. The front 5' of your booth may not exceed 4' in height unless the structure is see-through. Backdrops taller must get approval from Today's Bride. Some booth locations are restricted.

2) Maximum of four staff members are permitted to exhibit in a single booth space at one time. **Maximum of two staff members** permitted at one time in a Table Top Space.

3) NO distribution of any marketing materials is permitted in the event facility, outside of contracted booth space. This includes, but is not limited to: exhibit hall aisles, registration areas, seating areas, rest rooms, parking lot/garage or other event facility grounds.

4) No helium balloons are allowed in the facilities. Lit candles are permitted if they are in tall hurricanes, placed toward the back of the booth, and you bring a Fire 10# ABC extinguisher.

5) Distribution of any non-participating, non-contracted business literature (business cards, brochures, signage, etc.) is strictly prohibited. This includes, but is not limited to, photographs or displays with "courtesy of" acknowledgment of said businesses. The only exception is if the mentioned business is also an exhibitor at the current show.

6) Distributing literature or displaying signage regarding a competing Bridal Show or Event (whether at your facility or not) **is strictly prohibited** unless Today's Bride is a sponsor of the event.

7) Exhibitors MAY NOT begin to take down their booth display prior to show close. The take down, removal, or repackaging of booth materials and/or displays during posted bridal show hours is strictly prohibited. Any set-up and disassembly must take place prior to guests' arrival and after their exit. You will be held accountable for any injury that may occur as a result of your negligence, forfeit the show's lead list, risk approval to exhibit at future Today's Bride Shows, and be fined \$100. Additionally, guests pay admission for a show advertised with set hours of availability, and we must honor these hours.

8) All food and liquids to be served as samples must be approved by both the facility and Jadlyn Inc./Today's Bride at least two weeks before the show. Distribution of samples without prior approval is not permitted and may result in dismissal of exhibit space at the show. Sample sizes are restricted to 2oz or less for food, 3oz or less for liquids. Alcohol is strictly prohibited. If using heat for samples, exhibitor must bring a Fire 10# ABC extinguisher to keep at said booth.

9) Any outside food or drink for staff consumption is not permitted to be brought into the event facility. Concession areas are available to purchase snacks and food during meal times.

10) Distribution of alcoholic beverages, in any form, to attendees is strictly prohibited.

11) All audio, video and/or gaming productions must be maintained at appropriate noise levels so not to infringe on the peace and harmony of neighboring booths. Jadlyn Inc./Today's Bride reserves the right to determine and set the acceptable sound level. Exhibitor is responsible for compliance of all music licensing.

12) Your company/businesses must provide its own surge-suppressant power strip and extension cord(s) to use for your trade booth's electrical needs.

13) The leads generated from this show are for the exclusive use of the exhibitors who made the investment to participate. The lead lists are seeded. Today's Bride monitors what you are sending. It is a violation of your exhibitor agreement to sell, lend, reproduce, exchange, copy or share the lead list to any non-exhibiting business or non-sponsored show or event that isn't authorized for this list. If this information is used or threatened to be used in an unauthorized manner, Today's Bride shall be entitled to seek relief in any court of competent jurisdiction, including but not limited to injunctive relief, actual and punitive damages, reasonable attorney's fees, costs and any and all other expenses. It is also a violation to use the list or permit the list to be used to promote any other multi-business bridal- or wedding-related show or event, including Client's own participation within such an event, and that damages to Today's Bride for each such use shall be no less than \$3,000.00. (A "use" shall mean each letter, mailing or e-mail sent to an attendee on the lead list). Upon breach of this Contract for any reason, exhibitor's license to use such Lead List shall cease immediately.

14) Exhibitor shall make good any damage to the building or fixtures caused by exhibitor or any of exhibitors' agents or employees. Exhibitors are responsible for any loss of their equipment and/or display material, or personal belongings, resulting from accidental breakage, misplacement, theft, fire or natural disaster, including, but not limited to, damage occurring while Management staff is assisting an exhibitor. If exhibitor uses the services of Management staff, then exhibitor agrees that the staff member is a volunteer for the exhibitor for worker's compensation purposes.

15) The Exhibitor is responsible for insuring its exhibit, personnel, display, automobiles, trailers, and materials against any damage or loss resulting from theft, fire, accidents, or any other cause. The Exhibitor acknowledges and assumes all risks associated with the use of the exhibit space and its surroundings. The Exhibitor agrees not to make any claims, demands, or legal actions against Today's Bride/Jadlyn, Inc, the Show sponsors, or the facility hosting the Show for any loss, damage, or injury incurred by the Exhibitor, its officers, directors, agents, representatives, employees, or their respective property. Neither Today's Bride/Jadlyn, Inc. nor the facility will be liable for the loss or damage of equipment, products, goods, exhibits, or other materials owned, rented, or leased by the Exhibitor, regardless of the cause.

These and all existing regulations will be strictly enforced. Violation to regulations may result in the exclusion from future trade shows and/or forfeiture of trade show lead list.

MARKETING UPGRADES

PINK STUFF-IT BAG PROGRAM \$250* DEADLINE FEBRUARY 13, 2026



Guarantee every couple goes home with your marketing literature, whether you talked to them or not, by having your literature pre-stuffed in every pink welcome bag. All you need to do is supply us with **500 flyers** by **February 13, 2026**.

Ship or drop flyers off at:

Today's Bride, 3550 Ridgewood Road Fairlawn, Ohio 44333

- Payment must accompany flyers. • Limited availability for some categories (call for details).
- The flyers **CANNOT** contain names or phone numbers of non-show participating exhibitors.
- The flyers **CANNOT** advertise another bridal show (at your facility or elsewhere).
- The flyers **CANNOT** exceed 10 pages. No magazines allowed.
- All flyers must be a single piece item and FLAT (call for approval of anything else).

*must be an exhibitor to qualify for this discounted price.

TICKET SPONSORSHIPS*

Elevate your visibility at the show by sponsoring our online ticket sales! Your company logo will be prominently displayed and linked to your website across multiple pages as couples purchase their tickets. This opportunity not only enhances awareness of your presence at the show but also drives traffic to your website leading up to the event!

PRIMARY DISCOUNT SPONSOR \$800

SECONDARY ONLINE SPONSOR \$400

*LIMITED SPACE AVAILABLE

WEBSITE

TodaysBride.com is averaging 16,000+ visitors a month. Traffic increases 30% more before & after the shows. **NEW THIS YEAR!** You have the ability to update your online profile on TodaysBride.com. Visit www.TodaysBride.com/Dashboard and log in with your credentials. Under "Listings" you will see your online profile. Click "Edit" to make any changes. *Make sure to update your photo and weblink!*

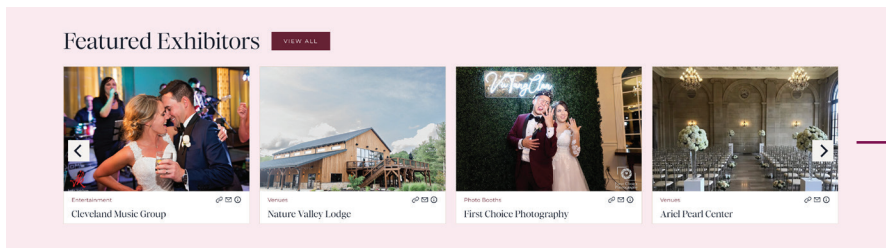

FEATURED EXHIBITOR AD \$150

Secure prime placement on the bridal show page with a rotating banner linked to your online profile. Banners are live from date of purchase through the show date.

FEATURED HOME PAGE PARTNER AD \$150

Secure prime placement on the TodaysBride.com home page with a rotating slider linked to your online profile + website.

Banners are live for one month after purchase.

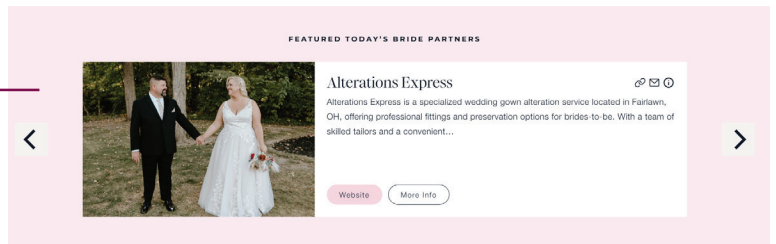

We also have different levels of online profiles you can upgrade to, social media promotions, and eblast options available for exhibitors. Please contact shows@todaysbride.com to learn more about availability and pricing.

To order the pink bag stuff-it program, ticket sponsorship, or online upgrades, please visit TodaysBride.com/pros/march-add

BOOTH DESIGN AWARD



MARCH 2025: CENTURY 21 WILBUR REALTY



MARCH 2025: THE RESERVE AT STONE CREEK

Go “all out” designing your booth and be rewarded with a Booth Design Award!

Your booth will be judged for Best Booth Design based on the following:

- ♥ Visual Display
- ♥ Creativity
- ♥ Functionality
- ♥ Staffing
- ♥ Best Use of Space
- ♥ Improvement from Year to Year

Need additional booth items to improve your display? Miller's Party Rental Center is the official decorator for the Today's Bride Wedding Show. They are offering discounted pricing on various rental items. Any items ordered will be placed in your booth space before the show unless you prefer to pick them up at their warehouse. Call 330-753-9104 with any questions and to place your order. **Deadline to order is February 27, 2026. Contact Angel at 330-753-9104 or amk@millersparty.com.**

DESIGN TIPS:

- 1. Most Important: Make sure your company name is prominent.** High and legible from a distance.
- 2. Consider adding lights to spotlight your products.** Exhibit halls have dim, indirect lighting. Lights will make a huge impact visually & your booth will stand out from a row of exhibits. (Bring your own extension cords and power strips!) Note: Please refer to our booth regulations regarding lighting on page 5.
- 3. Ditch the chairs and stand during the show.** Always appear interested and ready to assist potential customers.
- 4. Think UP!** Consider using vertical space in your booth. Invest in tall backdrops and banners up to 8' tall. Layer displays on a table. Rent high cocktail tables. Use barstools for your guests. You'll gain valuable square footage this way and the booth will be more appealing and functional.
- 5. Rent a unique backdrop.**

SPREAD THE WORD CONTEST

Promote the wedding show to your followers for a chance to win one of these three prizes:

FIRST PLACE



Win a Booth

at the November 22, 2026 Summit Co Fairgrounds Wedding Show (\$875 value)

SECOND PLACE



Win a Local Love Ad

Or credit towards a larger ad in the 2027 Today's Bride Magazine (\$625 value)

THIRD PLACE



Win an Email Blast

Sent by Today's Bride to 5,000+ brides (\$600 value)

**THE MORE YOU PROMOTE THE SHOW,
THE BETTER CHANCE OF WINNING!**

1 ENTRY	FOR EVERY SOCIAL MEDIA POST TO YOUR BUSINESS PAGE Post or share about being at the Today's Bride Wedding Show on your business social media accounts and tag @todaysbride to get points. A maximum of 3 points will be given for posts on the show day.
3 ENTRIES	FOR EACH BLOG POST THAT MENTIONS THE SHOW Send a link to points@TodaysBride.com.
3 ENTRIES	FOR MENTIONING THE SHOW IN YOUR EMAIL SIGNATURE OR VOICEMAIL Send an email to points@TodaysBride.com to let us know.
5 ENTRIES	FOR MENTIONING THE SHOW IN AN EMAIL BLAST Send an email blast to your prospect database inviting them to come and see you at the Today's Bride Wedding Show, and to contact you for free tickets. Add points@TodaysBride.com to your email list to receive credit.
10 ENTRIES	FOR ADDING THE "TODAY'S BRIDE PARTNER" BADGE & LINK TO YOUR WEBSITE. Download the 2026 badge at todaysbride.com/pros/badge and send a link to points@todaysbride.com.
15 ENTRIES	FOR MENTIONING THE SHOW IN ANY OTHER TRADITIONAL ADVERTISING (radio, TV, direct mail, print, etc.) Send an email to points@TodaysBride.com to let us know.

Each entry increases your chance of winning! Contest ends March 8, 2026, at 4:00 PM. Submit multiple entries for higher odds of winning!

Follow us on:      and tag us @todaysbride

(You must tag us to receive credit!)

*Must be on an official business account

Hashtag **#TodaysBride** to start a trend!

visit **TodaysBride.com/pros/promote**

for more banners, logos, and examples of how to create a post and how to tag us.



ATTRACT COUPLES TO YUR BOOTH WITH A SHOW SPECIAL

Show specials are a win-win for both couples & exhibitors at wedding shows! Attendees benefit by scoring deals and saving money, while exhibitors benefit by attracting more attention to their booth. Increase your chance of standing out, generating interest, and getting more leads by offering a limited-time show special.

NEED INSPIRATION?

DO YOU WANT SIGNED CONTRACTS?

- ♥ Book today for 10% off
- ♥ Sign this week to save \$100
- ♥ Book this week for only \$1,200
- ♥ Receive a free photo album when you book at the show

DO YOU WANT MORE BOOTH VISITORS?

- ♥ Spin the wheel for an instant gift
- ♥ Play Plinko for a discount
- ♥ Listen to our demo for a free koozie
- ♥ Stop by our booth for a free catering or cake sample

DO YOU WANT TO COLLECT MORE LEADS?

- ♥ Enter to win \$500 off any package
- ♥ Enter to win a free overnight stay
- ♥ Schedule an appointment to get \$75 off your gown
- ♥ Enter to win \$200 with any purchase

Let us know about your show promotion and we'll help get the word out by:

- Posting it on the show page on TodaysBride.com.
- Several will be mentioned in an email blast promoting the show and shared on social media

**EMAIL YOUR SPECIALS TO
ALYSSA@TODAYSBRIDE.COM**

or submit it with your credentials form at
todaysbride.com/pros/march-cred

PROMOTE YOUR SPECIAL ON SOCIAL MEDIA

Follow us on:



TAG us @todaysbride
so we can reshare!

GALLERY OF TABLES

With your expertise, couples can imagine their dream reception decor including table shapes, linens, centerpieces, chairs, china, and favors.

ATTENDEES VOTE ON THEIR FAVORITE DESIGN!
Voting is controlled by only one vote per attendee.

RESERVE YOUR SPACE TODAY!

SPACE IS RESERVED ON A
FIRST-COME, FIRST-SERVED BASIS

DEADLINE TO RESERVE: FEBRUARY 27, 2026

WHAT YOU NEED TO DO:

1. **Reserve your space:** Contact Abby Crowder at Abby@TodaysBride.com or 330-670-9545 x12.
2. **For your table:** It's a 10' x 10' space. You are responsible for bringing everything.

-OR-

Borrow items at **no extra cost*** from the gallery sponsor, Miller's Party Rental Center.

They offer tables, chairs, linens, flatware and more! Contact Veronica to place your order: 330-753-9104 or amk@millersparty.com

Deadline to order is **February 27, 2026**

GALLERY SPONSOR:

Miller's

PARTY RENTAL CENTER

We encourage collaboration with other exhibitors and will list them on the table sign created by Today's Bride. Any contributing companies must be exhibitors in the show to receive credit. Non-exhibitors may contribute, but their company is not permitted to be promoted on the table or in your exhibit space.

These spaces are for inspiration only. No promotional materials or literature (this includes business cards and signs) will be allowed in the gallery.

Gallery is open to venues, florists, planners, rental companies, or anyone who wants to showcase their design skills of what their business does.

*Only the gallery items are complimentary. Booth items can be rented for an additional fee.



GALLERY OF CAKES

Show off your decorating skills in the cake gallery and display your favorite cake designs!

Today's Bride will supply high-top tables covered & skirted with company name signage. Only cakes are permitted in the gallery. Candy or dessert stations not applicable.

ATTENDEES VOTE ON THEIR FAVORITE DESIGN!

Voting is controlled by only one vote per attendee.

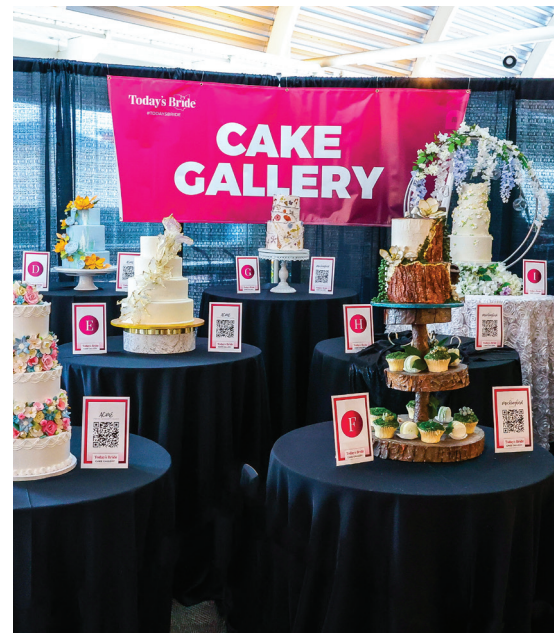

SPACE IS RESERVED ON A FIRST-COME, FIRST-SERVE BASIS
DEADLINE TO RESERVE: FEBRUARY 27, 2026

PORTRAIT GALLERY

Photographers have the opportunity to display their portraits at the show.

You will need to supply one easel per portrait (framed or unframed). Photos should be 16" x 20" or larger. Make sure your name is somewhere on the portrait or frame. Electric is an extra charge if needed.



GOWN GALLERY

Bring mannequins to feature the latest fashions, styles, and dresses in the gown gallery.

Tell us how many you're bringing and Today's Bride will supply a sign with your company name on it.



TO RESERVE SPACE IN THESE GALLERIES:

Reserve your space: Contact Abby Crowder at
Abby@TodaysBride.com or 330-670-9545 x12

ANY QUESTIONS?
CALL 330-670-9545 x12



EXHIBITOR SERVICES

AMAZON FAVORITES & SIGNS

Check out our Exhibitor Favorite Products on our amazon storefront:
Todaysbride.com/pros/favorite-products

Items such as tables, tape, carts, & custom design signs/backdrops.

Availability and turnaround is dependent on scheduled production at time of order.



For more samples & ideas visit
Todaysbride.com/pros/favorite-products
 or email shows@todaysbride.com



RENTALS

Miller's is the official decorator for the Today's Bride Wedding Show, offering discounted pricing on various rental items. The items will be placed in your booth space before the show unless you prefer to pick them up at their warehouse beforehand.



Call **330-753-9104**
 Angel, amk@millersparty.com
 with any questions and to place your order. Deadline to order is **February 27, 2026.**

PRINT



Looking for help with design and print of show materials? Today's Bride can help you with business cards, brochures, postcards, & more!



330-670-9545

Availability and turnaround is dependent on scheduled production at time of order.

EXHIBITOR WEBSITE

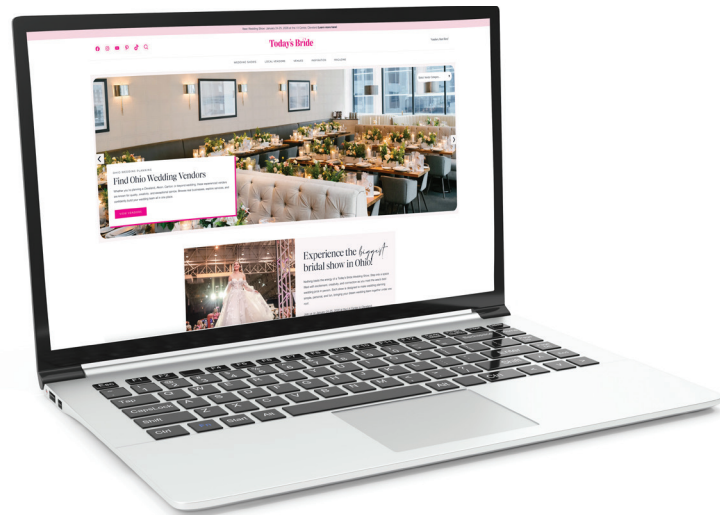

Please find this manual in its entirety plus deadlines, forms, inspiration, and helpful links at

TODAYSBRIDE.COM/PROS/MARCH

We appreciate you taking the time to review the Exhibitor Manual.

We are here to help you any way we can before, during and after the show. Don't hesitate to ask for our input on booth design ideas, marketing techniques and more. **330-670-9545 or 216-393-5677**

Jennifer Judy x14
 jennifer@todaysbride.com

Jim Frericks x16
 jim@todaysbride.com

Abby Frericks Crowder x12
 abby@todaysbride.com

Kay Grey x22
 kay@todaysbride.com

Julie Rauzan x24
 julie@todaysbride.com

Laura Stratton x25
 laura@todaysbride.com

Alyssa Myers x23
 alyssa@todaysbride.com



JOHN S. KNIGHT CENTER

The Center of an All-America® City

EXHIBITOR INFORMATION SUMMARY

On behalf of the John S. Knight Center Staff,
we would like to thank you for choosing to exhibit with us.

In order to achieve an efficient move-in, event and move-out,
we have summarized the following exhibitor information.

This information is in accordance with the Center's Building Rules &
Regulations document, as well as City, State and Federal regulations.

Wishing you a productive and memorable experience!



77 E. Mill Street / Akron, OH 44308
330.374.8900 / 800.245.4254
johnsknightcenter.org

MOVE-IN & MOVE-OUT REGULATIONS

The following are guidelines for move-in, move-out and set-up:

1. Exhibitors may hand carry or two-wheel dolly materials in and out of the building through designated move-in and move-out entrance(s). Should move-in and move-out require additional help, please contact a Center representative.
2. Exhibitors may use their own employees to set-up their booth. These must be regular employees of the exhibitors with a minimum of 60 days prior employment.
3. Exhibitors are not permitted to use any power-operated equipment for loading/unloading, setting-up or dismantling of exhibits.
4. All electrical wiring to booths/exhibits must be installed by the Center. Any connections within the booths/exhibits by exhibitor is permitted.

PARKING

The Center boasts ample and adjacent surface lots and parking decks for your use. A comprehensive map is available at www.johnsknightcenter.org. Handicap parking areas are clearly designated and are to be used only as specified by Local, State and Federal Laws. Additional staff parking spots are marked and are not available for general parking.

No parking in fire lanes, service streets, vacant Exhibit Halls, loading dock areas or any other locations posted "No Parking." This rule is strictly enforced. Any vehicle not in compliance will be removed at owner's expense.

ID BADGES

All personnel are required to have proper event ID badges, which must be worn on outer clothing at all times.

MAIL/DELIVERY

The Center cannot be held responsible for any shipment of goods accepted at the facility. As a building rule, the Center will accept shipments three (3) business days (Monday thru Friday, 9am to 4pm) before the event. Complete details are available in the Center's Building Rules & Regulations document.

BASIC FIRE CODE

To remain in compliance with the Akron Fire Code, please observe the following guidelines:

1. All materials used in exhibits must be flame retardant.
2. Firefighting and emergency equipment--including fire extinguishers, fire hose cabinets and fire alarm pull stations--may not be hidden or obstructed.
3. All emergency exits, hallways and aisle ways must be kept clear and unobstructed.
4. Vehicles, which are part of an exhibit, may be displayed if in compliance with the following Fire Code Regulations:
 - a. Vehicles may have no more than two (2) gallons of gas.
 - b. Gas tanks must be sealed with tape.
 - c. All battery cables must be disconnected and taped to avoid potential sparks.
 - d. All gasoline engines must be American Gas Association compliant.
5. The use of welding equipment, open flames or smoke emitting material as part of an exhibit must be specifically approved on an individual basis by the Akron Fire Department. Please submit written specifications to the Center for approval from the Akron Fire Department.
6. No person may use or permit the use of an Open Flame Lighting Device, nor may any person use or permit the use of a portable, non-flue-connected, cooking equipment in any place of assembly. (Akron Fire Code, Sect. 93.44-45)

SIGNS & DECORATIONS	<p>In order to preserve the building, exhibitors are asked to comply with the following guidelines:</p> <ol style="list-style-type: none"> 1. Special decorations, overhead signs and banners, light and sound equipment, etc., may not be hung from ceilings or walls except by Center personnel. 2. Decorations may not be taped, nailed, tacked or otherwise fastened to ceilings, walls, painted surfaces, columns, or decorative fabric. 3. All materials used during the event, such as landscape materials, trees, sand, dry-wall, lumber, etc., must be removed from the building immediately following the event.
BALLOONS, ETC.	<p>Helium balloons, "glitter," decals and/or stickers may not be passed out unless prior written approval has been obtained.</p>
PROHIBITED WEAPONS	<p>It is illegal to carry a firearm, deadly weapon or dangerous ordnance anywhere on Center premises.</p> <p>Unless otherwise authorized by law, no person shall knowingly possess, have under the person's control, convey, or attempt to convey a deadly weapon or dangerous ordnance onto these premises, pursuant to the Ohio Revised Code.</p>
PETS/ANIMALS	<p>The Center welcomes "service animals" pursuant to the Americans With Disabilities Act. In accordance with the Health Department, other pets/animals are not permitted in the building except in conjunction with an approved exhibit, display, or performance legitimately requiring the use of animals. Written approval from the Center must be obtained prior to the event.</p>
FOOD & BEVERAGE	<p>The Center offers a first-class food service department to accommodate visitors with all of their food and beverage needs. The Center also offers a large variety of concessions, specialty food carts, food courts, sidewalk cafes and much more.</p> <p>Exhibitors may NOT bring in any food/beverage into the building during move-in, move-out, or event hours.</p> <p>In the case of a Food Show, the Center retains the right to approve and limit the size of food or drink samples. Beverage items should be no more than 3 oz. sample sizes and food items should be no more than 2 oz. sample sizes.</p> <p>Exhibitors are not permitted to sell or distribute any food or beverage, whether for consumption on or off premises, without prior written permission from the Center.</p>
TIPS/GRATUITIES	<p>Although we appreciate the kind gesture of offering tips and gratuities, the Center asks that you forego this generosity.</p>
ADDITIONAL SERVICES	<p>Attached please find order and payment forms for: electrical services, audio-visual services, communication services, and plumbing services. If you require any additional services not listed, please contact a Center representative.</p>

Revised: 07.2016

More information and order forms for audio visual and electrical needs can be found at www.johnsknightcenter.org Click on EXHIBITOR INFORMATION toolbar.